

Kategoria: N O W O Ś C I / Category: N E W P R O D U C T S

Nr katalog. Art. No.	Symbol i rozmiar Reference name and size	Cena ¹ za op. Price PLN/box	Ilość w opak. Box (pcs)	EAN13 59077249 ...	Nr katalog. Art. No.	Symbol i rozmiar Reference name and size	Cena ¹ za op. Price PLN/box	Ilość w opak. Box (pcs)	EAN13 59077249 ...
-------------------------	--	--	-------------------------------	--------------------------	-------------------------	--	--	-------------------------------	--------------------------



FBQL* - Wysokiej jakości przedłużane, szlifowane wiertło do metalu FESTmann®, stal HSS, 2-stopniowy wierzchołek 135°, DIN 340 (NWKa)

FESTmann® long spiral HSS twist drill bit, fully ground, 135° split point, DIN 340

F02301	FBQL 2.0/85 (P10)	20,00 zł	10	15939
F02302	FBQL 3.0/100 (P10)	30,00 zł	10	15946
F02303	FBQL 3.2/106 (P10)	40,00 zł	10	15953
F02304	FBQL 3.5/112 (P10)	40,00 zł	10	15960
F02305	FBQL 4.0/119 (P10)	50,00 zł	10	15977
F02306	FBQL 4.2/119 (P10)	60,00 zł	10	15984
F02307	FBQL 4.5/126 (P10)	60,00 zł	10	15991
F02308	FBQL 5.0/132 (P10)	70,00 zł	10	16004
F02309	FBQL 5.5/139 (P10)	90,00 zł	10	16011
F02310	FBQL 6.0/139 (P10)	100,00 zł	10	16028
F02311	FBQL 6.5/148 (P10)	120,00 zł	10	16035
F02312	FBQL 7.0/156 (P10)	140,00 zł	10	16042
F02313	FBQL 8.0/165 (P5)	95,00 zł	5	16059
F02314	FBQL 10.0/184 (P5)	145,00 zł	5	16066
F02315	FBQL 12.0/205 (P5)	220,00 zł	5	16073

* Wiertła w opakowaniach po 10 sztuk (rozmiary 2.0 - 7.0) lub po 5 sztuk (rozmiary 8.0 - 12.0)

* Drills packed by 10 pcs (sizes 2.0 - 7.0) and by 5 pcs (sizes 8.0 - 12.0)

Nr katalog. Art. No.	Symbol i rozmiar Reference name and size	Cena ¹ za szt. PLN price per piece	Ilość w opak. Box (pcs)	EAN13 59077249 ...
-------------------------	--	---	-------------------------------	--------------------------



CHEM-PACK - Walizka z kompletem

akcesoriów do kotwienia*

(6 szt. VAM - mieszadła statyczne,

1 szt. VAP - pompka do wydmuchiwania zwiercin,

4 szt. SZM - szczotki do czyszczenia otworów,

4 szt. SH - plastikowe tuleje do kotwienia w materiałach otworowych)

Plastic case with installation accessories for chemical anchors*

(6pcs mixing nozzles, 1pc blow pump,

4pcs steel hand brushes, 4pcs perforated sleeves)

2113.0001	CHEM-PACK	240,00 zł	1	66146
-----------	-----------	-----------	---	-------

* Nie zawiera pistoletu ani zapraw / * Extrusion gun and cartridges not included

Warianty walizek CHEM-PACK dostępne do 2020-09-30 zostały wycofane z oferty

CHEM-PACK sets available until 2020-09-30 are discontinued

Kategoria: N O W O Ś C I / Category: N E W P R O D U C T S

Nr katalog. Art. No.	Symbol i rozmiar Reference name and size	Cena ¹ za szt. PLN price per piece	Ilość w opak. Box (pcs)	EAN13 59077249 ...	Nr katalog. Art. No.	Symbol i rozmiar Reference name and size	Cena ¹ za szt. PLN price per piece	Ilość w opak. Box (pcs)	EAN13 59077249 ...
-------------------------	--	---	-------------------------------	--------------------------	-------------------------	--	---	-------------------------------	--------------------------

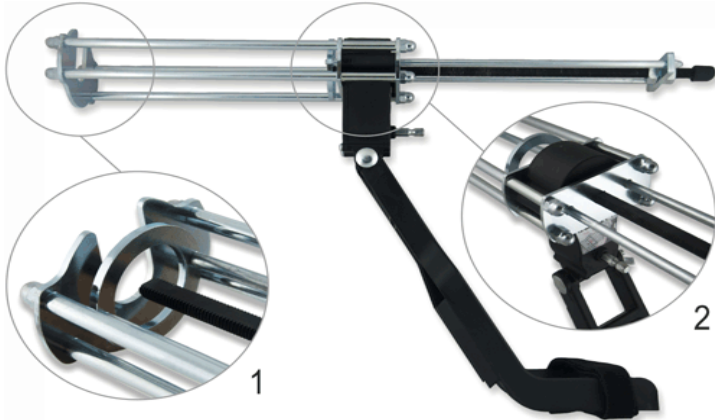

CHEM-AD - Profesjonalny adapter do wyciskania kartuszy z silikonami lub chemicznymi zaprawami kotwiącymi przy użyciu wkrętkarki akumulatorowej

Professional drill adapter for dispensing chemical and silicone cartridges using cordless screwdriver

- 1. Rewolucyjny produkt - trwała konstrukcja ze stali oraz duży docisk dzięki specjalnie utwardzonemu prętowi i tłokowi.**
Revolutionary product - durable construction made of steel and high pressure due to specially hardened bar and piston.
- 2. Innowacyjny mechanizm przesuwu - wysokie przełożenie siły optymalne do wyciskania kotew chemicznych.**
Innovative shift mechanism - high force transmission optimal for dispensing chemical anchors.



CHEM-AD 150-310



CHEM-AD 380-410

2116.0001	CHEM-AD 150-310	329,00 zł	1	15885	2116.0002	CHEM-AD 380-410	899,00 zł	1	15892
-----------	-----------------	-----------	---	-------	-----------	-----------------	-----------	---	-------



VAG - Profesjonalny, lekki pistolet ręczny do wyciskania zapraw kotwiących

Professional, lightweight caulking gun for dispensing chemical anchor cartridges

2041.0000	VAG 150-300	43,00 zł	1	17476
-----------	-------------	----------	---	-------

Kategoria: N O W O Ś C I / Category: N E W P R O D U C T S

Nr katalog. Art. No.	Symbol i rozmiar Reference name and size	Cena ¹ za op. Price PLN/box	Ilość w opak. Box (pcs)	EAN13 59077249 ...	Nr katalog. Art. No.	Symbol i rozmiar Reference name and size	Cena ¹ za op. Price PLN/box	Ilość w opak. Box (pcs)	EAN13 59077249 ...
-------------------------	--	--	-------------------------------	--------------------------	-------------------------	--	--	-------------------------------	--------------------------

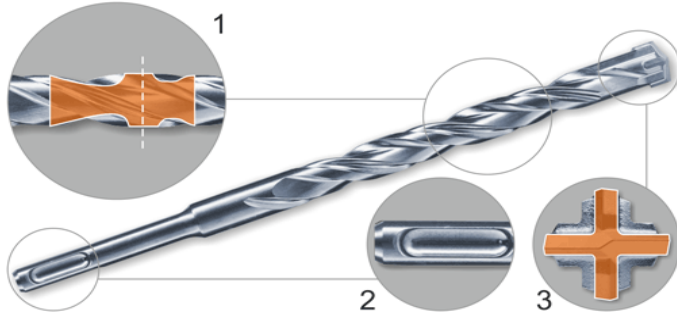

X+ - Wiertło udarowe FESTmann® z poczwórną, krzyżową widią, uchwyt SDS-plus, dedykowane do wiercenia w betonie

- szybsze, precyzyjne wiercenie,
- zredukowane drgania,
- dłuższa żywotność.

FESTmann® rotary hammer drill bit with a SDS-plus shank, 4-cutter, dedicated for drilling in concrete

- faster, precise drilling,
- reduced fiction,
- increased durability.

1. Zmienny rowek spirali:

- zapewnia dużą trwałość i odporność na pękanie wiertła,
- optymalizuje wyprowadzanie zwiercin z wierconych otworów.

2. Uchwyt SDS-Plus - skutecznie przenosi moment obrotowy i zapewnia szybkie osadzenie wiertła w uchwycie wiertarki.
3. Krzyżowa widia wiertła X+ z centrującym szpicem:

- geometria głowy 4x90° zapewnia precyzyjne otwory przez cały czas użytkowania wiertła,
- centrujący szpic zapobiega ślizganiu się wiertła po gładkiej powierzchni.

1. Variable flute:

- provides maximum fracture resistance,
- optimizes removing drilled material from the hole.

2. SDS-Plus shank - effectively transmits torque moment and provides quick change of drill bit in the drill chuck.
3. 4-cutter with centering tip:

- head geometry 4x90° guarantees precision holes during the whole lifetime of the drill,
- centering tip prevents the drill bit from going off course on smooth surfaces.

F02201	X+ 6/110 (P10)	185,00 zł	10	15724	F02207	X+ 10/160 (P10)	240,00 zł	10	15786
F02202	X+ 6/160 (P10)	200,00 zł	10	15731	F02208	X+ 10/210 (P10)	285,00 zł	10	15793
F02203	X+ 6/210 (P10)	255,00 zł	10	15748	F02209	X+ 10/260 (P10)	345,00 zł	10	15809
F02204	X+ 8/160 (P10)	220,00 zł	10	15755	F02210	X+ 12/210 (P10)	360,00 zł	10	15816
F02205	X+ 8/210 (P10)	265,00 zł	10	15762	F02211	X+ 12/260 (P10)	430,00 zł	10	15823
F02206	X+ 8/260 (P10)	315,00 zł	10	15779	F02212	X+ 12/310 (P10)	595,00 zł	10	15830

Nr katalog. Art. No.	Symbol i rozmiar Reference name and size	Cena ¹ za szt. PLN price per piece	Ilość w opak. Box (pcs)	EAN13 59077249 ...
-------------------------	--	---	-------------------------------	--------------------------



FW - Frez do wycinania otworów Ø65mm w materiałach izolacyjnych (m.in. wełnie mineralnej), głębokość otworu 20mm, uchwyt sześciokątny, stal kwasoodporna

Hole cutter for insulation material (incl. mineral wool), Ø65mm, hole depth 20mm, hexagon shank, acid-resistant steel

1065.0001	FW 65	145,00 zł	1	15397
-----------	-------	-----------	---	-------

Nr katalog. Art. No.	Symbol i rozmiar Reference name and size	Cena ¹ za 100szt. /Price PLN/100 pcs	Ilość w opak. Box (pcs)	EAN13 59077249 ...
-------------------------	--	---	-------------------------------	--------------------------

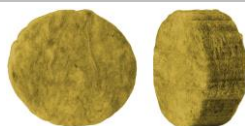

ZW - Zaślepka z wełny mineralnej, współczynnik przewodzenia ciepła λ=0,038

Mineral wool hole cap, thermal conductivity λ=0.038

1066.0001	ZW 67	65,00 zł	200	12914
-----------	-------	----------	-----	-------

Kategoria: N O W O Ś C I / Category: N E W P R O D U C T S

Nr katalog. Art. No.	Symbol i rozmiar Reference name and size	Cena ¹ za szt. PLN price per piece	Ilość w opak. Box (pcs)	EAN13 59077249 ...	Nr katalog. Art. No.	Symbol i rozmiar Reference name and size	Cena ¹ za szt. PLN price per piece	Ilość w opak. Box (pcs)	EAN13 59077249 ...
-------------------------	--	---	-------------------------------	--------------------------	-------------------------	--	---	-------------------------------	--------------------------



FBQ - Wysokiej jakości szlifowane wiertło do metalu FESTmann®, stal HSS, 2-stopniowy wierzchołek 135°, DIN 338 (NWKa)



FESTmann® spiral HSS twist drill bit, fully ground, 135° split point, DIN 338

F02001	FBQ 1.0/34	0,60 zł	10	14017	F02019	FBQ 6.0/93	4,30 zł	10	14192
F02002	FBQ 1.5/40	0,65 zł	10	14024	F02020	FBQ 6.1/101	5,20 zł	10	14208
F02003	FBQ 2.0/49	0,75 zł	10	14031	F02021	FBQ 6.2/101	5,20 zł	10	14215
F02004	FBQ 2.5/57	1,05 zł	10	14048	F02022	FBQ 6.5/101	5,20 zł	10	14222
F02005	FBQ 3.0/61	1,85 zł	10	14055	F02023	FBQ 7.0/109	6,50 zł	10	14239
F02006	FBQ 3.1/65	1,95 zł	10	14062	F02024	FBQ 7.5/109	7,20 zł	10	14246
F02007	FBQ 3.2/65	1,95 zł	10	14079	F02025	FBQ 8.0/117	7,70 zł	5	14253
F02008	FBQ 3.3/65	2,05 zł	10	14086	F02026	FBQ 8.5/117	8,90 zł	5	14260
F02009	FBQ 3.5/70	2,05 zł	10	14093	F02027	FBQ 9.0/125	11,10 zł	5	14277
F02010	FBQ 4.0/75	2,30 zł	10	14109	F02028	FBQ 9.5/125	11,60 zł	5	14284
F02011	FBQ 4.1/75	2,45 zł	10	14116	F02029	FBQ 10.0/133	12,90 zł	5	14291
F02012	FBQ 4.2/75	2,45 zł	10	14123	F02030	FBQ 10.5/133	14,50 zł	5	14307
F02013	FBQ 4.5/80	2,65 zł	10	14130	F02031	FBQ 11.0/142	16,10 zł	5	14314
F02014	FBQ 4.8/86	3,20 zł	10	14147	F02032	FBQ 11.5/142	18,00 zł	5	14321
F02015	FBQ 5.0/86	3,20 zł	10	14154	F02033	FBQ 12.0/151	20,00 zł	5	14338
F02016	FBQ 5.1/86	3,35 zł	10	14161	F02034	FBQ 12.5/151	21,50 zł	5	14345
F02017	FBQ 5.2/86	3,35 zł	10	14178	F02035	FBQ 13.0/151	23,00 zł	5	14352
F02018	FBQ 5.5/93	3,90 zł	10	14185					



FBQS - Zamykana kasetka plastikowa FESTmann® z zestawem wysokiej jakości szlifowanych wiertel do metalu FBQ, stal HSS, 2-stopniowy wierzchołek 135°, DIN 338 (NWKa)

FESTmann® plastic box with a set of FBQ spiral HSS twist drill bits, fully ground, 135° split point, DIN 338

F02101	FBQS 13	45,00 zł	1	14369	F02102	FBQS 19	115,00 zł	1	14376
--------	---------	----------	---	-------	--------	---------	-----------	---	-------

Kaseta 13szt: / 13pcs box: Ø1.5/2/2.5/3/3.2/3.5/4/4.5/4.8/5/5.5/6/6.5

Kaseta 19szt: / 19pcs box: Ø1/1.5/2/2.5/3/3.5/4/4.5/5/5.5/6/6.5/7/7.5/8/8.5/9/9.5/10



FSD - Podwójny/dwustronny klucz płaski FESTmann®, stal CrV, polerowany, DIN 3110

FESTmann® double open end spanner, CrV steel, polished, DIN 3110

F01033	FSD 06/07	4,40 zł	1	14925	F01037	FSD 17/19	12,00 zł	1	15038
F01034	FSD 08/10	4,90 zł	1	14932	F01038	FSD 19/22	15,50 zł	1	15045
F01035	FSD 10/13	6,50 zł	1	14949	F01039	FSD 24/27	19,50 zł	1	15052
F01036	FSD 13/17	8,80 zł	1	14956	F01040	FSD 30/32	28,00 zł	1	15069



FSDS* - Zestaw podwójnych/dwustronnych kluczy płaskich FESTmann®, stal CrV, polerowane, DIN 3110

Set of FESTmann® double open end spanners, CrV steel, polished DIN 3110

F01106	FSDS 06	39,00 zł	1	15083	F01107	FSDS 08	105,00 zł	1	15090
--------	---------	----------	---	-------	--------	---------	-----------	---	-------

* Zawartość (po 1 sztuce) / * Includes (1 piece each):

FSDS 06 (6/7, 8/9, 10/11, 12/13, 14/15, 16/17mm),

FSDS 08 (6/7, 8/10, 10/13, 13/17, 17/19, 19/22, 24/27, 30/32mm)

Kategoria: N O W O Ś C I / Category: N E W P R O D U C T S

Nr katalog. Art. No.	Symbol i rozmiar Reference name and size	Cena ¹ za szt. PLN price per piece	Ilość w opak. Box (pcs)	EAN13 59077249 ...	Nr katalog. Art. No.	Symbol i rozmiar Reference name and size	Cena ¹ za szt. PLN price per piece	Ilość w opak. Box (pcs)	EAN13 59077249 ...
-------------------------	--	---	-------------------------------	--------------------------	-------------------------	--	---	-------------------------------	--------------------------

FSO - Odgięty, dwustronny klucz oczkowy FESTmann®, stal CrV, polerowany, DIN 838
FESTmann® offset ring spanner, CrV steel, polished, DIN 838

F01041	FSO 06/07	6,80 zł	1	15106	F01047	FSO 18/19	14,00 zł	1	15168
F01042	FSO 08/09	7,20 zł	1	15113	F01048	FSO 20/22	20,00 zł	1	15175
F01043	FSO 10/11	7,70 zł	1	15120	F01049	FSO 21/23	21,00 zł	1	15182
F01044	FSO 12/13	8,40 zł	1	15137	F01050	FSO 24/27	28,00 zł	1	15212
F01045	FSO 14/15	11,00 zł	1	15144	F01051	FSO 25/28	32,00 zł	1	15236
F01046	FSO 16/17	12,50 zł	1	15151	F01052	FSO 30/32	39,00 zł	1	15243

FSOS* - Zestaw odgiętych, dwustronnych kluczy oczkowych FESTmann®, stal CrV, polerowane, DIN 838
Set of FESTmann® offset ring spanners, CrV steel, polished DIN 838

F01108	FSOS 06	65,00 zł	1	15250	F01110	FSOS 12	225,00 zł	1	15274
F01109	FSOS 08	102,00 zł	1	15267					

*** Zawartość (po 1 sztuce) / * Includes (1 piece each):**
FSOS 06 (6/7, 8/9, 10/11, 12/13, 14/15, 16/17mm),
FSOS 08 (6/7, 8/9, 10/11, 12/13, 14/15, 16/17, 18/19, 20/22mm),
FSOS 12 (6/7, 8/9, 10/11, 12/13, 14/15, 16/17, 18/19, 20/22, 21/23, 24/27, 25/28, 30/32mm)

FSC - Klucz płasko-oczkowy FESTmann®, stal CrV, polerowany, DIN 3113
FESTmann® combination spanner, CrV steel, polished, DIN 3113

F01020	FSC 09	4,00 zł	1	14468	F01027	FSC 34	81,00 zł	1	14567
F01021	FSC 20	11,60 zł	1	14475	F01028	FSC 36	88,00 zł	1	14574
F01022	FSC 23	15,40 zł	1	14482	F01029	FSC 38	103,00 zł	1	14598
F01023	FSC 25	18,60 zł	1	14499	F01030	FSC 41	140,00 zł	1	14604
F01024	FSC 26	20,60 zł	1	14505	F01031	FSC 46	185,00 zł	1	14710
F01025	FSC 28	26,00 zł	1	14543	F01032	FSC 50	226,00 zł	1	14826
F01026	FSC 29	30,50 zł	1	14550					

FSS* - Zestaw kluczy płasko-oczkowych, FESTmann®, stal CrV, polerowane, DIN 3113

F01104	FSS 17	205,00 zł	1	14895	F01105	FSS 25	315,00 zł	1	14901
--------	--------	-----------	---	-------	--------	--------	-----------	---	-------

*** Zawartość (po 1 sztuce) / * Includes (1 piece each):**
FSS 17 (6, 8, 10, 11, 12, 13, 14, 15, 16, 17, 18, 19, 22, 24, 27, 30, 32mm),
FSS 25 (6, 7, 8, 9, 10, 11, 12, 13, 14, 15, 16, 17, 18, 19, 20, 21, 22, 23, 24, 25, 26, 27, 28, 30, 32mm)

Kategoria: N O W O Ś C I / Category: N E W P R O D U C T S

Nr katalog. Art. No.	Symbol i rozmiar Reference name and size	Cena ¹ za szt. PLN price per piece	Ilość w opak. Box (pcs)	EAN13 59077249 ...	Nr katalog. Art. No.	Symbol i rozmiar Reference name and size	Cena ¹ za szt. PLN price per piece	Ilość w opak. Box (pcs)	EAN13 59077249 ...
-------------------------	--	---	-------------------------------	--------------------------	-------------------------	--	---	-------------------------------	--------------------------



STS-TIN - Stopniowe, stożkowe, tytanowane (TiN) wiertło do metalu, stal HSS, rowek spiralny

HSS step drill bit, titanium nitrided (TiN coated), spiral flute

5034.0005	STS-TIN 4-39	106,00 zł	1	14406	5034.0006	STS-TIN 6-42	115,00 zł	1	14413
-----------	--------------	-----------	---	-------	-----------	--------------	-----------	---	-------



STS - Stopniowe, stożkowe wiertło do metalu, stal HSS, rowek spiralny

HSS step drill bit, spiral flute

5032.0005	STS 4-39	104,00 zł	1	14383	5032.0006	STS 6-42	113,00 zł	1	14390
-----------	----------	-----------	---	-------	-----------	----------	-----------	---	-------

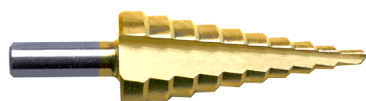

STP-TIN - Stopniowe, stożkowe, tytanowane (TiN) wiertło do metalu, stal HSS, rowek prosty

HSS step drill bit, titanium nitrided (TiN coated), straight flute

5033.0005	STP-TIN 4-39	81,00 zł	1	14444	5033.0006	STP-TIN 6-42	93,00 zł	1	14451
-----------	--------------	----------	---	-------	-----------	--------------	----------	---	-------



STP - Stopniowe, stożkowe wiertło do metalu, stal HSS, rowek prosty

HSS step drill bit, straight flute

5030.0005	STP 4-39	79,00 zł	1	14420	5030.0006	STP 6-42	91,00 zł	1	14437
-----------	----------	----------	---	-------	-----------	----------	----------	---	-------

Nr katalog. Art. No.	Symbol i rozmiar Reference name and size	Cena ¹ za 100szt. /Price PLN/100 pcs	Ilość w opak. Box (pcs)	EAN13 59077249 ...	Nr katalog. Art. No.	Symbol i rozmiar Reference name and size	Cena ¹ za 100szt. /Price PLN/100 pcs	Ilość w opak. Box (pcs)	EAN13 59077249 ...
-------------------------	--	---	-------------------------------	--------------------------	-------------------------	--	---	-------------------------------	--------------------------



GXK - Nylonowy dybel uniwersalny, przedłużony, rozpirający w czterech kierunkach, z wkrętem o łbie stożkowym, nacięcie pozidriv

Universal, long nylon plug, 4-directional expansion zone, with a chipboard screw, countersunk head, pozidriv recess

1081.0007	GXK 6/60/45	21,00 zł	100	15298	1081.0008	GXK 8/70/50	30,00 zł	100	15311
-----------	-------------	----------	-----	-------	-----------	-------------	----------	-----	-------

Oznaczenie: średnica koszulki / długość wkręta / długość koszulki; GXK 6/60/45 - wkręt z pełnym gwintem, GXK 8/70/50 - półgwint
 Description: plug diameter / screw length / plug length; GXK 6/60/45 - fully threaded screw, GXK 8/70/50 - partial thread

Kategoria: N O W O Ś C I / Category: N E W P R O D U C T S
CENY ZMIENIONE Z DNIEM 2020.05.06 / REVISED PRICES SINCE 2020.05.06

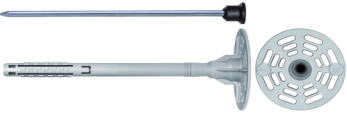
Nr katalog. Art. No.	Symbol i rozmiar Reference name and size	Cena ¹ za 100szt. /Price PLN/100 pcs	Ilość w opak. Box (pcs)	EAN13 59077249 ...	Nr katalog. Art. No.	Symbol i rozmiar Reference name and size	Cena ¹ za 100szt. /Price PLN/100 pcs	Ilość w opak. Box (pcs)	EAN13 59077249 ...
					APM* - Dybel do mocowania termoizolacji fasadowych z trzpieniem stalowym z główką z tworzywa <i>Facade wall insulation plug with a plastic head steel expansion nail</i>				
1024.0069	APM 10/100	65,00 zł	100	12440	1024.0048	APM 10/240	132,00 zł	100	64791
1024.0070	APM 10/120	71,00 zł	100	12457	1024.0049	APM 10/260	142,00 zł	100	64807
1024.0071	APM 10/140	77,00 zł	100	12464	1024.0050	APM 10/280	165,00 zł	100	64814
1024.0072	APM 10/160	91,00 zł	100	12471	1024.0051	APM 10/300	180,00 zł	100	64821
1024.0073	APM 10/180	99,00 zł	100	63664	1024.0052	APM 10/340	520,00 zł	100	85376
1024.0074	APM 10/200	113,00 zł	100	63671	1024.0053	APM 10/380	570,00 zł	50	03936
1024.0080	APM 10/220	122,00 zł	100	63688	1024.0054	APM 10/420	660,00 zł	50	04001

* Produkt może różnić się wzorem / * Product may have a different design



CENY ZMIENIONE Z DNIEM 2019.11.18 / REVISED PRICES SINCE 2019.11.18



Nr katalog. Art. No.	Symbol i rozmiar Reference name and size	Cena ¹ za 100szt. /Price PLN/100 pcs	Ilość w opak. Box (pcs)	EAN13 59077249 ...	Nr katalog. Art. No.	Symbol i rozmiar Reference name and size	Cena ¹ za 100szt. /Price PLN/100 pcs	Ilość w opak. Box (pcs)	EAN13 59077249 ...
					WTZ - Wkręt ciesielski do drewna, łeb talerzowy, nacięty szpic, spiralne frezy rozwiercające, gniazdo torx, ocynkowany na żółto <i>Wood carpentry screw, wafer head, shank ribs, cut point, torx recess, yellow zinc plated</i>				
3059.2022	WTZ 8.0/40	45,00 zł	50	12945	3059.2012	WTZ 8.0/260	225,00 zł	50	81279
3059.2023	WTZ 8.0/50	49,00 zł	50	12952	3059.2013	WTZ 8.0/280	245,00 zł	50	81286
3059.2021	WTZ 8.0/60	50,00 zł	50	88209	3059.2014	WTZ 8.0/300	270,00 zł	50	81293
3059.2006	WTZ 8.0/80	62,00 zł	50	81217	3059.2015	WTZ 8.0/320	320,00 zł	50	81309
3059.2001	WTZ 8.0/100	71,00 zł	50	80869	3059.2004	WTZ 8.0/340	355,00 zł	50	80890
3059.2002	WTZ 8.0/120	84,00 zł	50	80876	3059.2005	WTZ 8.0/360	385,00 zł	50	80906
3059.2007	WTZ 8.0/140	100,00 zł	50	81224	3059.2016	WTZ 8.0/380	450,00 zł	50	81316
3059.2003	WTZ 8.0/160	120,00 zł	50	80883	3059.2017	WTZ 8.0/400	495,00 zł	50	81323
3059.2008	WTZ 8.0/180	135,00 zł	50	81231	3059.2018	WTZ 8.0/420	890,00 zł	25	05893
3059.2009	WTZ 8.0/200	160,00 zł	50	81248	3059.2019	WTZ 8.0/440	990,00 zł	25	05909
3059.2010	WTZ 8.0/220	190,00 zł	50	81255	3059.2020	WTZ 8.0/450	1 000,00 zł	25	05916
3059.2011	WTZ 8.0/240	215,00 zł	50	81262					



Nr katalog. Art. No.	Symbol i rozmiar Reference name and size	Cena ¹ za szt. PLN price per piece	Ilość w opak. Box (pcs)	Średnica śruby Screw diameter	Nr katalog. Art. No.	Symbol i rozmiar Reference name and size	Cena ¹ za szt. PLN price per piece	Ilość w opak. Box (pcs)	Średnica śruby Screw diameter
					MMP-TEST* - Tuleja do testowania przydatności śrub multi-monti-plus do ponownego użycia w przypadku zamocowań tymczasowych <i>Gauge for checking reusability of multi-monti-plus screw anchor in temporary fastenings</i>				
3081.1001	MMP-TEST 10	99,00 zł	1	10	3081.1003	MMP-TEST 16	139,00 zł	1	16
3081.1002	MMP-TEST 12	119,00 zł	1	12	3081.1004	MMP-TEST 20	159,00 zł	1	20

* Produkt dostępny na specjalne zamówienie / * Product available on request

Kategoria: N O W O Ś C I / Category: N E W P R O D U C T S
CENY ZMIENIONE Z DNIEM 2019.09.09 / REVISED PRICES SINCE 2019.09.09

Nr katalog. Art. No.	Symbol i rozmiar Reference name and size	Cena ¹ za kg PLN price per kilogram	Ilość w opak. Box (kg)	EAN13 59077249 ...	Nr katalog. Art. No.	Symbol i rozmiar Reference name and size	Cena ¹ za kg PLN price per kilogram	Ilość w opak. Box (kg)	EAN13 59077249 ...
  <p>GS - Hartowany gwóźdź murarski, trzonek gładki, łeb stożkowy, ocynkowany połyskowo Hardened steel nail, countersunk head, bright zinc plated</p>									
4001.1015a	GS 4.2/60 (KG)	39,00 zł	1	64326	4001.1017a	GS 4.2/80 (KG)	38,00 zł	1	64340
4001.1016a	GS 4.2/70 (KG)	39,00 zł	1	64333					

  <p>GM - Gwóźdź mosiężny, gładki trzonek, zredukowany łeb Brass nail, lost head</p>									
4043.8001a	GM 1.5/20 (KG)	155,00 zł	1	64159	4043.8002a	GM 1.5/25 (KG)	150,00 zł	1	64166

Nr katalog. Art. No.	Symbol i rozmiar Reference name and size	Cena ¹ za 100szt. /Price PLN/100 pcs	Ilość w opak. Box (pcs)	EAN13 59077249 ...	Nr katalog. Art. No.	Symbol i rozmiar Reference name and size	Cena ¹ za 100szt. /Price PLN/100 pcs	Ilość w opak. Box (pcs)	EAN13 59077249 ...
  <p>GSM - Hartowany gwóźdź murarski, trzonek moletowany, łeb stożkowy, ocynkowany połyskowo Hardened steel nail, countersunk head, grooved shank, bright zinc plated</p>									
4002.1004	GSM 2.7/35	12,50 zł	250	06364	4002.1011	GSM 3.5/75	26,50 zł	250	06456
4002.1005	GSM 2.7/40	12,50 zł	250	06371	4002.1019	GSM 4.5/70	29,50 zł	250	06531
4002.1021	GSM 3.5/70	25,50 zł	250	06449					

CENY ZMIENIONE Z DNIEM 2019.06.10 / REVISED PRICES SINCE 2019.06.10

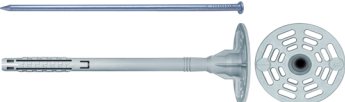
Nr katalog. Art. No.	Symbol i rozmiar Reference name and size	Cena ¹ za 100szt. /Price PLN/100 pcs	Ilość w opak. Box (pcs)	EAN13 59077249 ...	Nr katalog. Art. No.	Symbol i rozmiar Reference name and size	Cena ¹ za 100szt. /Price PLN/100 pcs	Ilość w opak. Box (pcs)	EAN13 59077249 ...
 <p>APG - Dybel do mocowania termoizolacji fasadowych z trzpieniem stalowym Facade wall insulation plug with a steel expansion nail</p>									
1031.0043	APG 10/160	61,00 zł	100	12433	1031.0048	APG 10/240	87,00 zł	100	72673
1031.0044	APG 10/180	67,00 zł	100	63596	1031.0049	APG 10/260	93,00 zł	100	72680
1031.0047	APG 10/200	72,00 zł	100	63602	1031.0050	APG 10/280*	153,00 zł	100	72697
1031.0046	APG 10/220	76,00 zł	100	63619	1031.0051	APG 10/300*	163,00 zł	100	72703

* Rozmiary różniące się wzorem / * Sizes with a different design

 <p>APS - Dybel do mocowania termoizolacji fasadowych z trzpieniem ze wzmocnionego tworzywa Facade wall insulation plug with a reinforced nylon expansion nail</p>									
1019.0045	APS 10/100*	29,00 zł	350	12358	1019.0047	APS 10/200	47,50 zł	100	63534
1019.0041	APS 10/120*	33,00 zł	300	12365	1019.0052	APS 10/220	51,00 zł	100	63541
1019.0042	APS 10/140*	37,00 zł	250	12372	1019.0053	APS 10/240	61,00 zł	100	11481
1019.0043	APS 10/160	39,50 zł	100	12389	1019.0054	APS 10/260	67,00 zł	100	11498
1019.0044	APS 10/180	43,00 zł	100	12396					

* Rozmiary różniące się wzorem, talerz $\varnothing=52\text{mm}$ / * Sizes with a different design, collar $\varnothing=52\text{mm}$

Kategoria: N O W O Ś C I / Category: N E W P R O D U C T S
CENY ZMIENIONE Z DNIEM 2019.05.15 / REVISED PRICES SINCE 2019.05.15

Nr katalog. Art. No.	Symbol i rozmiar Reference name and size	Cena ¹ za 100szt. /Price PLN/100 pcs	Ilość w opak. Bag (pcs)	Karton (szt.) Outer carton (pcs)	Nr katalog. Art. No.	Symbol i rozmiar Reference name and size	Cena ¹ za 100szt. /Price PLN/100 pcs	Ilość w opak. Bag (pcs)	Karton (szt.) Outer carton (pcs)
OK - Nylonowa opaska zaciskowa do kabli, przewodów elektrycznych oraz rur, biała									
 <i>White cable tie for electrical cables and pipes, nylon</i>									
1052.0010	OK 2.2/75*	4,10 zł	100	40 000	1052.0043	OK 4.8/390	33,00 zł	100	5 000
1052.0013	OK 2.5/98	3,55 zł	100	35 000	1052.0034	OK 4.5/430	36,50 zł	100	5 000
1052.0014	OK 2.5/135	5,20 zł	100	30 000	1052.0040	OK 7.8/180	29,50 zł	100	5 000
1052.0015	OK 2.6/160	6,30 zł	100	25 000	1052.0041	OK 7.8/240	37,50 zł	100	4 000
1052.0016	OK 2.6/200	7,50 zł	100	20 000	1052.0028	OK 7.8/300	43,50 zł	100	3 500
1052.0017	OK 3.5/140	7,20 zł	100	20 000	1052.0042	OK 7.5/365	50,50 zł	100	2 500
1052.0018	OK 3.5/200	10,20 zł	100	15 000	1052.0029	OK 7.5/450	71,50 zł	100	2 500
1052.0019	OK 3.5/290	13,70 zł	100	10 000	1052.0030	OK 7.5/540	89,00 zł	100	2 000
1052.0020	OK 3.5/370	25,00 zł	100	7 500	1052.0035	OK 7.5/750	123,00 zł	100	1 200
1052.0022	OK 4.5/160	12,30 zł	100	12 000	1052.0032	OK 9.0/780	171,00 zł	100	1 000
1052.0023	OK 4.8/178	12,80 zł	100	12 000	1052.0044	OK 12.5/225	89,00 zł	50	2 000
1052.0024	OK 4.8/200	13,30 zł	100	10 000	1052.0036	OK 12.5/500	151,00 zł	50	1 000
1052.0025	OK 4.8/250	16,00 zł	100	9 000	1052.0037	OK 12.5/720	182,00 zł	50	600
1052.0026	OK 4.5/290	19,40 zł	100	7 500	1052.0038	OK 12.5/850	270,00 zł	50	600
1052.0027	OK 4.5/360	22,70 zł	100	6 000	1052.0031	OK 12.5/1000	315,00 zł	50	500

* Rozmiar dostępny wyłącznie do wyczerpania zapasów / * Size available only while stocks last



OKC - Nylonowa opaska zaciskowa do kabli, przewodów elektrycznych oraz rur, czarna

 <i>Black cable tie for electrical cables and pipes, nylon</i>									
1071.0013	OKC 2.5/98	3,55 zł	100	35 000	1071.0034	OKC 4.5/430	36,50 zł	100	5 000
1071.0014	OKC 2.5/135	5,20 zł	100	30 000	1071.0040	OKC 7.8/180	29,50 zł	100	5 000
1071.0015	OKC 2.6/160	6,30 zł	100	25 000	1071.0041	OKC 7.8/240	37,50 zł	100	4 000
1071.0016	OKC 2.6/200	7,50 zł	100	20 000	1071.0028	OKC 7.8/300	43,50 zł	100	3 500
1071.0017	OKC 3.5/140	7,20 zł	100	20 000	1071.0042	OKC 7.5/365	50,50 zł	100	2 500
1071.0018	OKC 3.5/200	10,20 zł	100	15 000	1071.0029	OKC 7.5/450	71,50 zł	100	2 500
1071.0019	OKC 3.5/290	13,70 zł	100	10 000	1071.0030	OKC 7.5/540	89,00 zł	100	2 000
1071.0020	OKC 3.5/370	25,00 zł	100	7 500	1071.0035	OKC 7.5/750	123,00 zł	100	1 200
1071.0022	OKC 4.5/160	12,30 zł	100	12 000	1071.0032	OKC 9.0/780	171,00 zł	100	1 000
1071.0023	OKC 4.8/178	12,80 zł	100	12 000	1071.0044	OKC 12.5/225	89,00 zł	50	2 000
1071.0024	OKC 4.8/200	13,30 zł	100	10 000	1071.0036	OKC 12.5/500	151,00 zł	50	1 000
1071.0025	OKC 4.8/250	16,00 zł	100	9 000	1071.0037	OKC 12.5/720	182,00 zł	50	600
1071.0026	OKC 4.5/290	19,40 zł	100	7 500	1071.0038	OKC 12.5/850	270,00 zł	50	600
1071.0027	OKC 4.5/360	22,70 zł	100	6 000	1071.0031	OKC 12.5/1000	315,00 zł	50	500
1071.0043	OKC 4.8/390	33,00 zł	100	5 000					

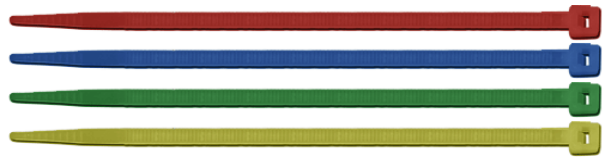
OKK - Nylonowa opaska zaciskowa do kabli, przewodów elektrycznych oraz rur, kolorowa
 (CW - czerwona, NB - niebieska, ZL - zielona, ZO - żółta)

 <i>Colour cable tie, nylon (CW - red, NB - blue, ZL - green, ZO - yellow)</i>									
1064.0001	OKK 2.5/98 CW	4,00 zł	100	35 000	1064.0103	OKK 3.5/200 ZL	11,30 zł	100	15 000
1064.0301	OKK 2.5/98 NB	4,00 zł	100	35 000	1064.0203	OKK 3.5/200 ZO	11,30 zł	100	15 000
1064.0101	OKK 2.5/98 ZL	4,00 zł	100	35 000	1064.0004	OKK 4.8/200 CW	15,00 zł	100	10 000
1064.0201	OKK 2.5/98 ZO	4,00 zł	100	35 000	1064.0304	OKK 4.8/200 NB	15,00 zł	100	10 000
1064.0002	OKK 3.5/140 CW	8,00 zł	100	20 000	1064.0104	OKK 4.8/200 ZL	15,00 zł	100	10 000
1064.0302	OKK 3.5/140 NB	8,00 zł	100	20 000	1064.0204	OKK 4.8/200 ZO	15,00 zł	100	10 000
1064.0102	OKK 3.5/140 ZL	8,00 zł	100	20 000	1064.0005	OKK 4.5/290 CW	22,50 zł	100	7 500
1064.0202	OKK 3.5/140 ZO	8,00 zł	100	20 000	1064.0305	OKK 4.5/290 NB	22,50 zł	100	7 500
1064.0003	OKK 3.5/200 CW	11,30 zł	100	15 000	1064.0105	OKK 4.5/290 ZL	22,50 zł	100	7 500
1064.0303	OKK 3.5/200 NB	11,30 zł	100	15 000	1064.0205	OKK 4.5/290 ZO	22,50 zł	100	7 500

Kategoria: N O W O Ś C I / Category: N E W P R O D U C T S

Nr katalog. Art. No.	Symbol i rozmiar Reference name and size	Cena ¹ za metr Price PLN/1 meter	Metrów w rolce Reel [m]	EAN13 59077249 ...	Nr katalog. Art. No.	Symbol i rozmiar Reference name and size	Cena ¹ za metr Price PLN/1 meter	Metrów w rolce Reel [m]	EAN13 59077249 ...
 					LG - łańcuch gospodarczy, zgrzewany, krótkie oczko, ocynkowany, na rolce, DIN 5685A Short link chain, welded, zinc plated, on a reel, DIN 5685A				
7117.1001	LG 2	1,80 zł	100*	-	7117.1008	LG 7	12,10 zł	16*	-
7117.1002	LG 3	2,70 zł	60*	-	7117.1006	LG 8	15,90 zł	10*	-
7117.1003	LG 4	4,00 zł	40*	-	7117.1007	LG 10	26,00 zł	10*	-
7117.1004	LG 5	6,30 zł	30*	-	7117.1009	LG 12	36,20 zł	8*	-
7117.1005	LG 6	9,30 zł	20*	-	* Ilości w rolce zależą od partii / * Reel size depends on batch				

Nr katalog. Art. No.	Symbol i rozmiar Reference name and size	Cena ¹ za metr Price PLN/1 meter	Metrów w rolce Reel [m]	EAN13 59077249 ...	Nr katalog. Art. No.	Symbol i rozmiar Reference name and size	Cena ¹ za metr Price PLN/1 meter	Metrów w rolce Reel [m]	EAN13 59077249 ...
 					LGD - łańcuch gospodarczy, zgrzewany, długie oczko, ocynkowany, na rolce, DIN 5685C Long link chain, welded, zinc plated, on a reel, DIN 5685C				
7118.1001	LGD 2	1,60 zł	100*	-	7118.1005	LGD 6	8,20 zł	20*	-
7118.1002	LGD 3	2,50 zł	60*	-	7118.1006	LGD 8	14,70 zł	10*	-
7118.1003	LGD 4	3,95 zł	40*	-	7118.1007	LGD 10	21,70 zł	10*	-
7118.1004	LGD 5	5,80 zł	30*	-	* Ilości w rolce zależą od partii / * Reel size depends on batch				

Nr katalog. Art. No.	Symbol i rozmiar Reference name and size	Cena ¹ za 100szt. /Price PLN/100 pcs	Ilość w opak. Box (pcs)	EAN13 59077249 ...	Nr katalog. Art. No.	Symbol i rozmiar Reference name and size	Cena ¹ za 100szt. /Price PLN/100 pcs	Ilość w opak. Box (pcs)	EAN13 59077249 ...
PG* - Pręt z gwintem metrycznym, ocynkowany na biało, stal klasy 4.8, DIN 975 Metric threaded rod, zinc plated, steel grade 4.8, DIN 975									
									
2081.1003	PG 5/1000	185,00 zł	100	11665	2081.1012	PG 18/1000	1 850,00 zł	10	89527
2081.1004	PG 6/1000	230,00 zł	50	06777	2081.1009	PG 20/1000	2 200,00 zł	10	06906
2081.1005	PG 8/1000	325,00 zł	50	06807	2081.1010	PG 22/1000	3 100,00 zł	5	11627
2081.1006	PG 10/1000	510,00 zł	25	06821	2081.1011	PG 24/1000	3 600,00 zł	5	11634
2081.1007	PG 12/1000	690,00 zł	20	06845	2081.1013	PG 27/1000	5 500,00 zł	5	11641
2081.1020	PG 14/1000	1 070,00 zł	15	06869	2081.1014	PG 30/1000	6 000,00 zł	5	11658
2081.1008	PG 16/1000	1 460,00 zł	10	06883					

CENY ZMIENIONE Z DNIEM 2018.11.21 / REVISED PRICES SINCE 2018.11.21

Nr katalog. Art. No.	Symbol i rozmiar Reference name and size	Cena ¹ za 100szt. /Price PLN/100 pcs	Ilość w opak. Box (pcs)	EAN13 59077249 ...	Nr katalog. Art. No.	Symbol i rozmiar Reference name and size	Cena ¹ za 100szt. /Price PLN/100 pcs	Ilość w opak. Box (pcs)	EAN13 59077249 ...
KSD - Rozporowa tuleja stalowa z gwintem wewnętrznym Drop-in anchor with an internal metric thread, zinc plated									
									
2057.2004	KSD M12	99,00 zł	50	45424	2057.2005	KSD M16	239,00 zł	25	67631

OGRANICZENIE ODPOWIEDZIALNOŚCI / LIMITATION OF LIABILITY:

Wszelkie informacje, opublikowane w dowolnej formie w wykazie nowości produktowych ARVEX GROBELNY Sp. z o.o. przedstawione zostały w stanie na chwilę obecną i tak jak są dostępne. ARVEX GROBELNY Sp. z o.o. nie gwarantuje dokładności, ani kompletności informacji w tym wykazie, a także nie ponosi odpowiedzialności za ewentualne braki czy błędy we wspomnianych informacjach. ARVEX GROBELNY Sp. z o.o. nie ponosi odpowiedzialności za jakiegokolwiek pośrednie lub bezpośrednie szkody powstałe w wyniku korzystania z wykazu nowości produktowych oraz poniesione w wyniku wykorzystania informacji w nim zawartych. Wykaz nowości produktowych ma charakter informacyjny i nie stanowi oferty handlowej w rozumieniu Art.66 §1 Kodeksu Cywilnego.

All information published in any form in this new product list of ARVEX GROBELNY Sp. z o.o. are presented as is at the date of publication. ARVEX GROBELNY Sp. z o.o. makes no warranty as to the accuracy or completeness of the information presented in this list and assumes no liability whatsoever for the possible deficiencies or mistakes in the aforementioned information. ARVEX GROBELNY Sp. z o.o. assumes no liability for any direct or indirect damage caused as a result of using this list and assumes no liability in connection with any use of information contained in it. This list is for informational purposes only and does not constitute an offer within the meaning of Art.66 §1 of the Polish Civil Code.